

BO170B

BOLLARDS AND HEIGHT RESTRICTORS

Revision: 15 July 2025 4:36 PM
Boplan reference: BO170B...

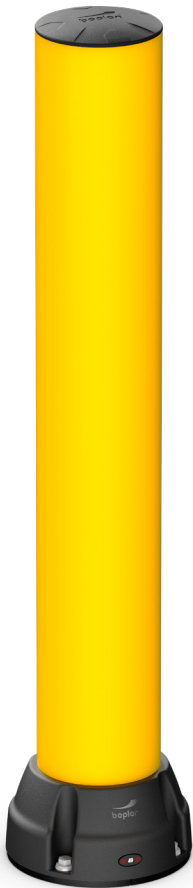

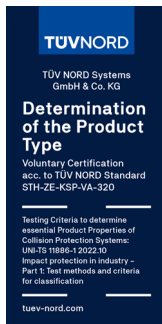





Base Defender with Impact Button

PRODUCT SPECIFICATIONS

APPLICATION		
Environment	The BO170B provides reliable protection for gates, access ways, corners, and machinery. With its medium-sized diameter, this solution strikes an ideal balance between strength and practicality. Robust yet flexible, it is suitable for both indoor and outdoor environments. Due to the large base, pallets are kept at a certain distance from the bollard to protect hands and prevent injury. Ideal for situations with a moderate risk of collisions.	
Impact performance	7500 Joule (Eq. to 3,8 ton - 7.2 km/h) - Following UNI 11886-1	
MATERIAL		
Tube	Extrilene® - UV resistant - Fire class E ⁺ - Non conductive - Impervious to most chemicals**	
Cap	Sustainable elastomer	
Base Defender	Sustainable elastomer	
COLOURS		
Bollard	Standard: Yellow RAL 1003 Also available in Black RAL 9005 (multicolour)	
Base Defender	Standard: Black RAL 9005	
OPTIONAL		
Stripes	Coloured reflective stripes providing a high level of visibility.	
BASEPLATES		
	Zinc Coated Steel	Stainless steel
Material	Steel 37	Stainless steel 304
Coating	Electroplated + Lacquered	No lacquer / No coating
Colour	Mat black	Natural colour

*Classification according to EN 13501-1:2007 +A1:2009 - Fire classification of construction products and building elements.
**Ask your local sales office for resistance to specific chemicals.

		FIXATIONS	
		ZC (Zinc coated)	SS (Stainless steel)
STANDARD	Concrete screw	 Ø14mm x 130mm 	Not available
ALTERNATIVE	Wedge anchor	 Ø12mm (M12) x 135mm 	Ø12mm (M12) x 125mm 
	Asphalt anchor	 Bolt M10 x 40mm + Screw Ø16mm	Not available

The anchors specified in this document are metric. Imperial anchors are available on demand.



FEATURES AND FUNCTIONALITY - B0170B

SIZE	
Height	450 mm 750 mm 1000 mm 1200 mm
Profile section	Ø168 mm
Baseplate	Ø250 mm (10 mm thick)
Base Defender	Top: Ø168 mm Base: Ø254 mm Height: 122 mm

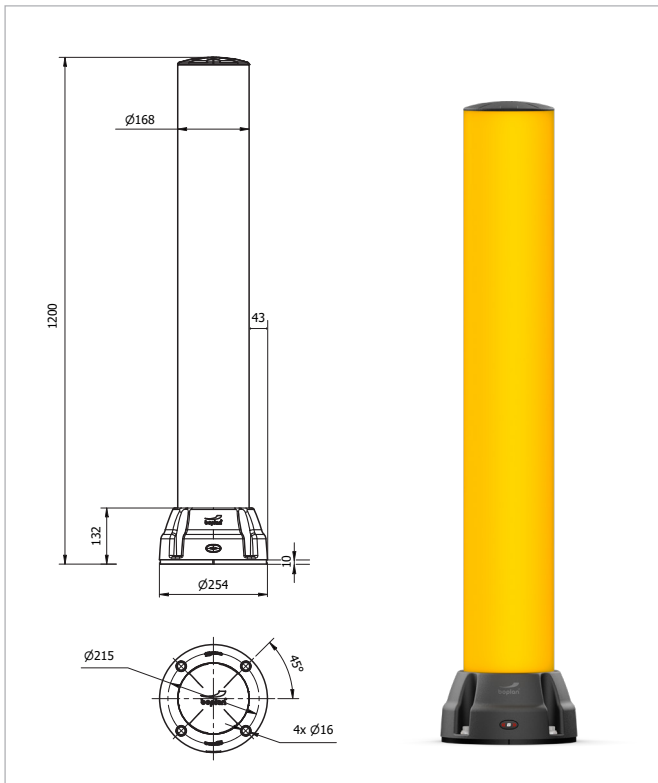

REQUIREMENTS	
Concrete quality	minimum C25/30
Concrete floor plate thickness (mm)	minimum 150 mm
Concrete slab dimension around posts (mm)	600 (h) x 600 (w) x 500 (d)
Operational temperature	-10°C up to +40°C
Water and humidity	Zinc coated: Indoor and outdoor use in most environments. Stainless steel: outdoor use or frequent exposure to water and humidity.

boplan IMPACT LABEL SAFETY GATES		BOLLARD 170B	
BOPLAN IMPACT CATEGORY	RATING	90°	UNI 11886-1
X	50 kJ		ENERGY CLASS
T	40 kJ		3
F	30 kJ		OPERATIONAL FOOTPRINT
R	25 kJ		W630
B	20 kJ		ASI CLASS
L	17 kJ		a
	15 kJ		
	12 kJ		
	10 kJ		
	7.5 kJ		
	5.0 kJ		
	2.5 kJ		
	0.5 kJ		
<i>*Dynamic impact result: 7500 joule</i>			
IMPACT TEST RESULTS AT 90°		 $\alpha = 20^\circ$ D = 410.4 mm / 16.2 inch	
PRODUCT: BBO170B0-1200-0001YEZ Deflection (D) At maximum impact energy		TEST CONDITIONS FOLLOWING UNI 11886-1 AND PAS13: 2017 TEMPERATURE: 20°C / 68°F IMPACT ON MIDDLE OF RAILS AND MIDDLE OF POST IMPACT HEIGHT: 300 mm / 47.2 Inch -> D: 410.4 mm / 16.2 Inch -> α : 20° TEST FLOOR: CONCRETE SLAB C25/30 - 150 mm / 6 Inch	
TEST VEHICLE: TYPE: BOPLAN IMPACT TEST VEHICLE WEIGHT: 3775 kg / 8322.45 lbs SIZE (L x W x h): 3100 x 1100 x 1150 mm / 122 x 43.3 x 45.3 Inch CONTACT AREA, STEEL BUMPER WIDTH: 1000 mm / 39.4 Inch		BOPLAN TEST CENTRE Muizelstraat 12 8560 Moorsele Belgium Approved by: TÜV NORD Systems 	
* IMPACT VALUE ACCOUNTING FOR BARRIER DEFORMATION DURING IMPACT		IL-B0170B-20250404	

FEATURES AND FUNCTIONALITY - B0170B

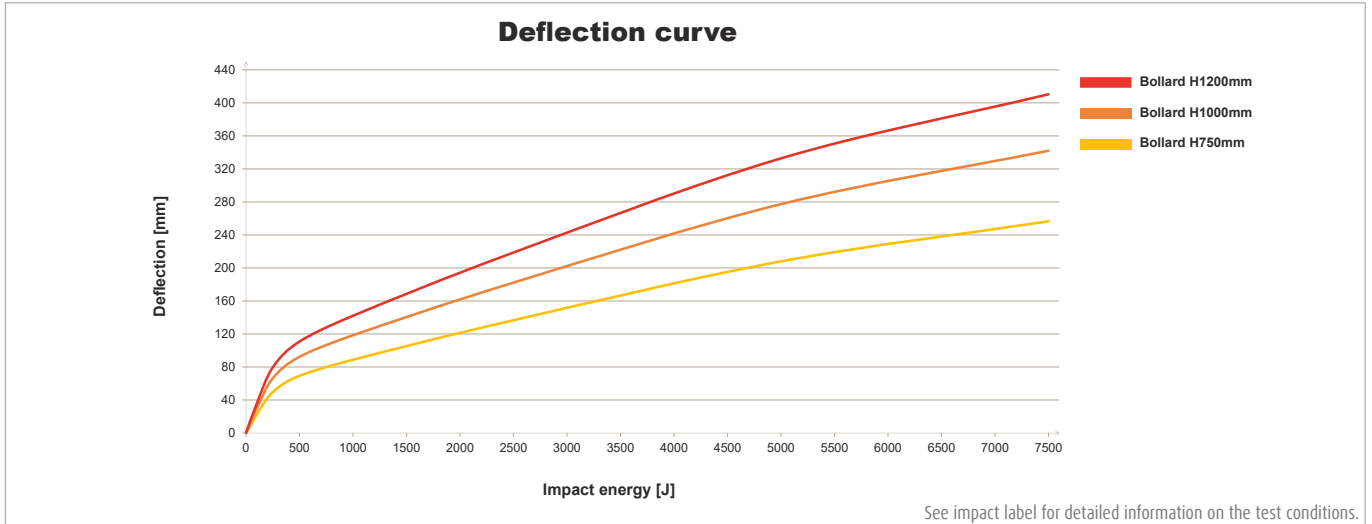

REFERENCE LIST - B0170B

	ZINC COATED (ZC)		STAINLESS STEEL (SS)	
	YELLOW	MULTICOLOUR ■	YELLOW	MULTICOLOUR ■
450 mm	BO170B0-0450-0001YEZ	BO170B0-0450-0001MCZ	BO170B0-0450-0001YES	BO170B0-0450-0001MCS
750 mm	BO170B0-0750-0001YEZ	BO170B0-0750-0001MCZ	BO170B0-0750-0001YES	BO170B0-0750-0001MCS
1000 mm	BO170B0-1000-0001YEZ	BO170B0-1000-0001MCZ	BO170B0-1000-0001YES	BO170B0-1000-0001MCS
1200 mm	BO170B0-1200-0001YEZ	BO170B0-1200-0001MCZ	BO170B0-1200-0001YES	BO170B0-1200-0001MCS

STRIPES (not included)

	Black	White	Yellow
1 STRIPE	PA0300-0170-0001BL	PA0300-0170-0001WH	PA0300-0170-0001YE
2 STRIPES	PA0300-0170-0002BL	PA0300-0170-0002WH	PA0300-0170-0002YE





* Remark: Stripes cannot be ordered separately